

# GP600 GENERAL PURPOSE CONFIGURABLE RACKMOUNT SYSTEM

## GP600 OVERVIEW

The GP600 is a flexible rackmount system that can be built with any combination of fiber optic device, such as Optical Switches, WDMs, VOAs, Couplers, Tap Detectors, Transceivers, Delays, EDFAs, Fast Receivers, Tunable Filters, etc.

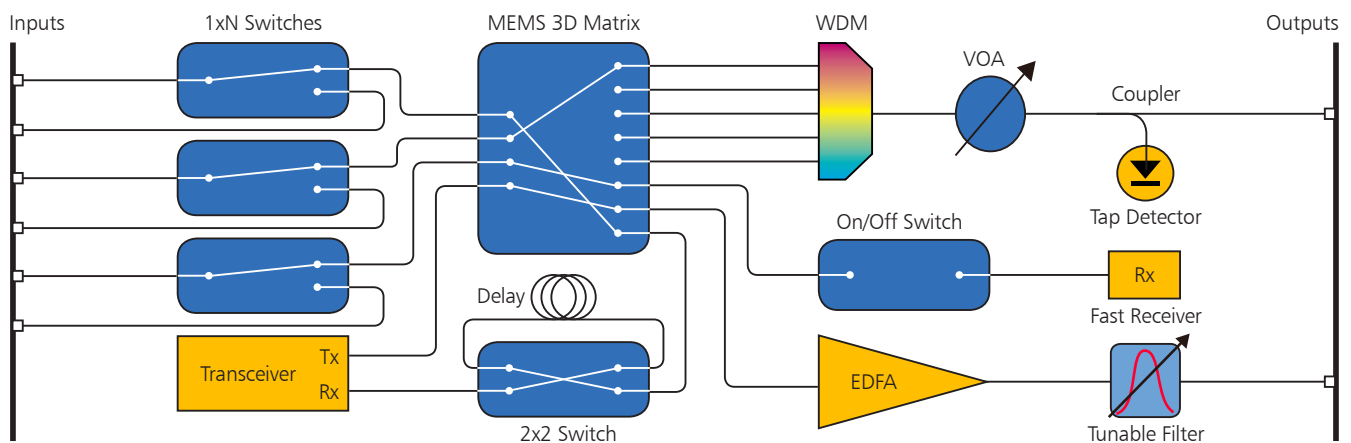
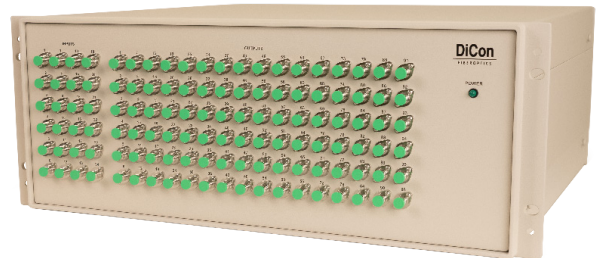

## FEATURES

- Control via a single interface
- Expertly built-to-order
- Available in custom configurations

## APPLICATIONS

- Test & Measurement
- Fiber Monitoring
- Commercial & Defense Networks



1689 Regatta Blvd.  
Richmond, CA 94804  
(510) 620-5200  
[www.diconfiberoptics.com](http://www.diconfiberoptics.com)

**Commercial Business**  
[sales@diconfiberoptics.com](mailto:sales@diconfiberoptics.com)  
**US Government Business**  
[sales@diconusa.com](mailto:sales@diconusa.com)

# GP600 GENERAL PURPOSE CONFIGURABLE RACKMOUNT SYSTEM

## SINGLEMODE OPTICAL SWITCHES

### TABLE OF CONTENTS

MEMS 1xN Switches .....	3 - 4
MEMS 3D Matrix Switches .....	5 - 6
Chassis Specifications .....	7 - 8

DiCon Fiberoptics' MEMS Singlemode Optical Switches allow the automated and repeatable connection of one fiber to the other.

- Industry proven MEMS technology
- Reliable, long life design
- High density to minimize rack space

### MEMS 1xN OPTICAL SWITCH

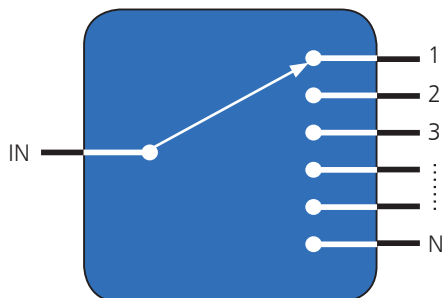

**Up to 1x128**

### MEMS 3D MATRIX OPTICAL SWITCH

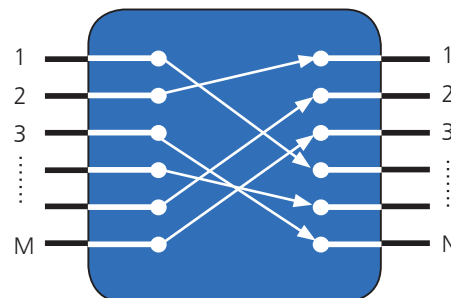

**Up to 96x96**

# GP600 - SINGLEMODE OPTICAL SWITCHES

## MEMS 1xN OPTICAL SWITCHES

DiCon's industry proven MEMS 1xN optical switches enable the automated connection of one common fiber to any of N output fibers.

- Reliable MEMS technology
- Lifetime > 1 billion switch cycles
- Bi-directional, all-optical design

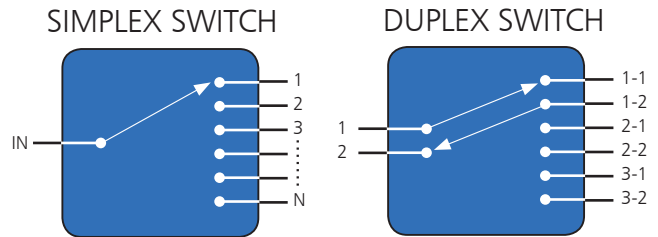

## OPTICAL SPECIFICATIONS (Specifications without connectors at approx. 23°C.)

Parameter	Band	Range (nm)	Tested at (nm)	1x8	1x12	1x16	1x32	1x96	1x128
Insertion Loss, Max. (dB)	Single Band	1290 - 1330	1310	0.8	1.2	1.5	1.5	2.0	2.4
		1530 - 1570	1550						
		1570 - 1610	1590						
		1625 - 1650	1650						
Dual Band	1290 - 1330 & 1530 - 1570	1310 & 1550	1.0	1.4	1.7	1.7	2.2	2.6	
	1530 - 1570 & 1570 - 1610	1550 & 1590							
Crosstalk (dB)	-50 Max.								
Back-Reflection (dB)	-50 Max.								
Switching Time (ms)	40 Max.								
WDL (dB)	0.3 Max. (Up to 1x32) // 0.4 Max. (Up to 1x128)								
PDL (dB)	0.1 Max. (Single Band) // 0.15 Max. (Dual Band)								
Repeatability (dB)	0.02 Max. (Up to 1x12) // 0.04 Max. (Up to 1x128)								
Durability (cycles)	1 Billion Min.								
Optical Power	500 mW Max.								
Fiber Type	9/125 um single mode								

# GP600 - SINGLEMODE OPTICAL SWITCHES

## MEMS 1xN ORDERING INFORMATION

**GP600** -  -  -  /  -  -  -  -  -

**Product Code**

**GP600** GP600 System

**Chassis Type**

- 1U** 1U Rackmount
- 2U** 2U Rackmount
- 4U** 4U Rackmount
- 4E** 4U Extended Rackmount
- B** Benchtop Chassis

**Product Type**

**MS** MEMS 1xN Optical Switch

**Number of Switches**

**#** Number of Switches

**Switch Type**

- 1xN** 1xN Simplex (N≤128)
- 1xN/DS** 1xN Duplex (N≤96)

**Wavelength Range**

- 13** 1290 - 1330 nm
- 15** 1530 - 1570 nm
- 16** 1570 - 1610 nm
- U** 1625 - 1650 nm
- 13/15** 1290 - 1330 nm & 1530 - 1570 nm
- 15/16** 1530 - 1570 nm & 1570 - 1610 nm

**Fiber and Jacket Type**

**9** SMF-28

**Connector Type**

- FC** FC/UPC
- FC/APC** FC/APC
- LC** LC/UPC
- LC/APC** LC/APC
- SC** SC/UPC
- SC/APC** SC/APC
- ST** ST/UPC
- ST/APC** ST/APC
- E2000/APC** E2000/APC

**Connector Location**

- F** Front Panel
- R** Rear Panel

# GP600 - SINGLEMODE OPTICAL SWITCHES

## MEMS 3D MATRIX OPTICAL SWITCHES

DiCon's MEMS 3D Matrix optical switches are high reliability, all optical, non-blocking fiber optic switches that enables the simultaneous connection of multiple fibers to one another.

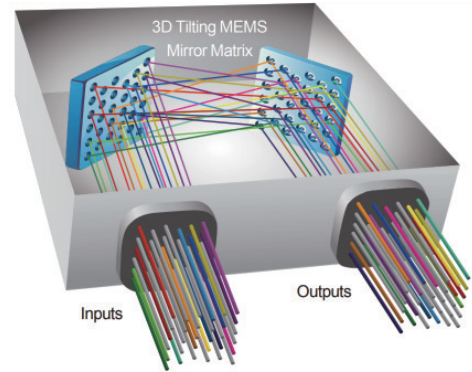

- Proven MEMS technology
- All optical, cross-connect design
- Lifetime > 1 billion switch cycles
- Available up to 96x96

## OPTICAL SPECIFICATIONS (Specifications without connectors at approx. 23°C.)

Parameter	Operating Bands (nm)	Tested at (nm)	8x8	16x16	32x32	64x64	96x96
Insertion Loss, (dB)	1290 - 1330	1310	0.9 Typ. // 1.6 Max.				
	1530 - 1570	1550	0.8 Typ. // 1.4 Max.				
	1570 - 1610	1590	0.9 Typ. // 1.6 Max.				
Crosstalk (dB)	-70 Typ. // -55 Max.						
Back-Reflection (dB)	-55 Typ. // -45 Max.						
Switching Time (ms)	15 Typ. // 20 Max.						
WDL (dB)	0.1 Typ. // 0.4 Max. (each operating band)						
PDL (dB)	0.08 Typ. // 0.25 Max.						
Repeatability (dB)	0.01 Typ. // 0.06 Max.						
Durability (cycles)	1 Billion Min.						
Optical Power	500 mW Max.						
Fiber Type	9/125 um single mode						

# GP600 - SINGLEMODE OPTICAL SWITCHES

## MEMS 3D MATRIX ORDERING INFORMATION

**GP600** - □ - □ - □ / □ - □ - □ - □ - □

**Product Code**

**GP600** GP600 System

**Chassis Type**

- 1U** 1U Rackmount
- 2U** 2U Rackmount
- 4U** 4U Rackmount
- 4E** 4U Extended Rackmount
- B** Benchtop Chassis

**Product Type**

**MN** MEMS 3D Matrix Optical Switch

**Number of Switches**

**#** Number of Switches

**Switch Type**

- MxN** MxN Simplex (M,N≤96)
- MxN/DS** MxN Duplex (M,N≤96)

**Wavelength Range**

- 13** 1290 - 1330 nm
- 15** 1530 - 1570 nm
- 16** 1570 - 1610 nm
- 13/15** 1290 - 1330 nm & 1530 - 1570 nm
- 15/16** 1530 - 1570 nm & 1570 - 1610 nm
- 13/15/16** 1290 - 1330 nm, 1530 - 1570 nm, 1570 - 1610 nm

**Fiber and Jacket Type**

**9** SMF-28

**Connector Type**

- FC** FC/UPC
- FC/APC** FC/APC
- LC** LC/UPC
- LC/APC** LC/APC
- SC** SC/UPC
- SC/APC** SC/APC
- ST** ST/UPC
- ST/APC** ST/APC
- E2000/APC** E2000/APC

**Connector Location**

- F** Front Panel
- R** Rear Panel

# GP600 - CHASSIS

## ELECTRICAL SPECIFICATIONS

Parameter		Rating
Control	Interface	Ethernet 10/100 Base T and RS-232
	Ethernet/RS-232 Switch	Manual slide switch on rear to select control method
Power Supply	Voltage	90 - 264 VAC
	Frequency	47 - 63 Hz
	On/Off Switch	2-position toggle on rear
Connectors	Ethernet	RJ45 female receptacle
	RS-232	DB9 female receptacle
	Power Supply	IEC 60320 C13 female receptacle (standard AC connector)
	Location	Rear of chassis
Power LED	On State	GP600 is on (Receiving power and power switch is in on position)
	Off State	GP600 is off (Not receiving power, or power switch is in off position)
	Location	Front of chassis

### Benchtop Chassis

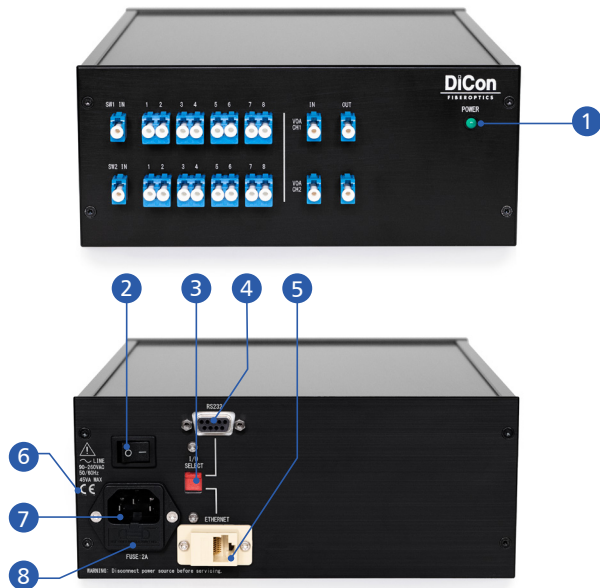

- 1 Power LED
- 2 Rocker Switch (Toggle to turn unit on and off)
- 3 I/O Select (Switch used to select the one active interface)
- 4 RS-232, DB9 Connector
- 5 Ethernet, RJ45 Connector
- 6 CE Mark
- 7 Power Cord Inlet
- 8 Replaceable Fuse

# GP600 - CHASSIS

## MECHANICAL SPECIFICATIONS (Dimensions in inches (in) are approximate for reference.)

Chassis	Height		Width		Depth	
	mm	in	mm	in	mm	in
1U	44	1.7	483	19	342	13.5
2U	88	3.5	483	19	435	17.1
4U	177	7.0	483	19	435	17.1
4U Extended (4E)	177	7.0	483	19	554	21.8
Benchtop (B)	88	3.5	210	8	250	9.8

## MAXIMUM # OF CONNECTORS

Chassis Size	Panel	FC FC/APC	ST ST/APC	SC SC/APC	LC LC/APC
1U	Front	43	43	57	85
	Rear	11	11	21	24
2U	Front	73	73	89	145
	Rear	55	55	72	121
4U	Front	225	225	240	381
	Rear	190	190	201	288
Benchtop	Front	37	37	60	81
	Rear	24	24	32	56

## ENVIRONMENTAL SPECIFICATIONS

Parameter	Rating
Operating Temp	0 to 50°C
Storage Temp	-20 to 60°C
Relative Humidity	0% to 80% non-condensing