

# GP700 PLATFORM

## CHASSIS OPTIONS

### CHASSIS SUMMARY

Chassis	Width	Height <sup>1</sup>	Depth
2U half-rack	222.0 mm	88.9 mm	367.25 mm
2U standard rackmount	483.0 mm	88.9 mm	434.5 mm
4U standard rackmount	483.0 mm	178.0 mm	434.5 mm
4U extended rackmount <sup>2</sup>	483.0 mm	178.0 mm	554.0 mm
6U extended rackmount	483.0 mm	265.9 mm	554.0 mm
Benchtop	257.4 mm	191.6 mm	412.6 mm

1. Excluding feet.
2. Not shown. Differs from 4U standard rackmount chassis only in depth.

### 4U STANDARD RACKMOUNT CHASSIS

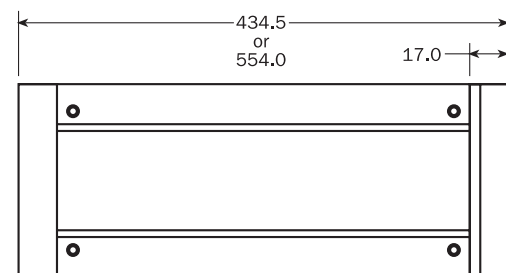
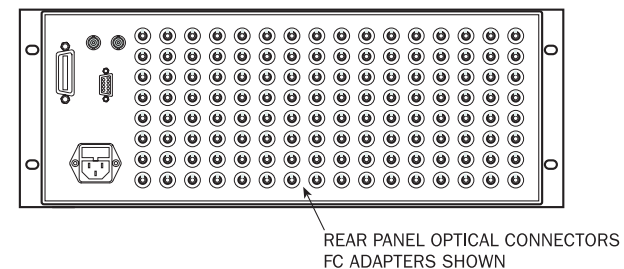
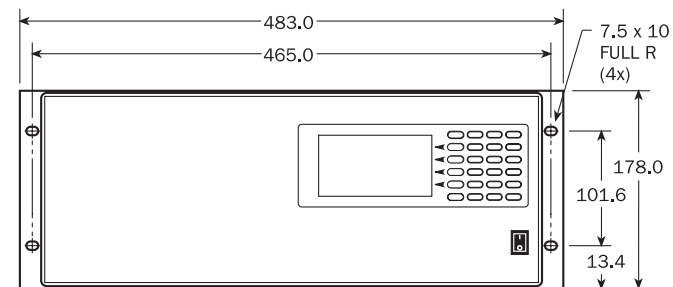

### 6U EXTENDED RACKMOUNT CHASSIS

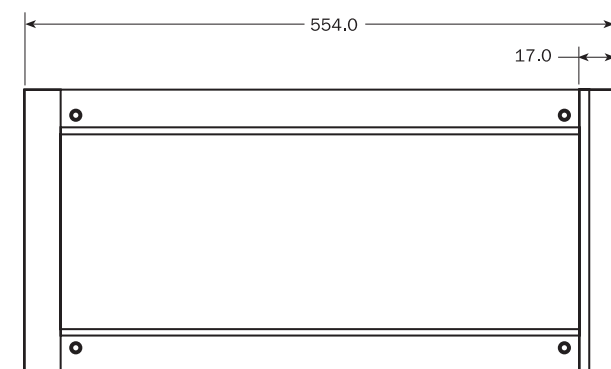
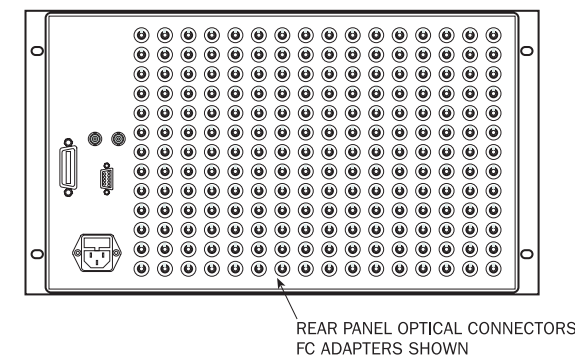
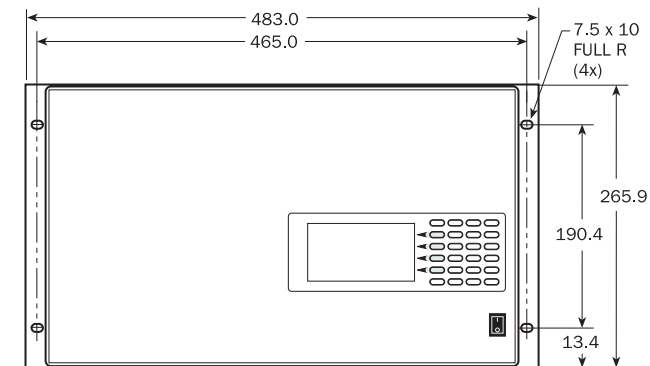

### 2U STANDARD RACKMOUNT CHASSIS

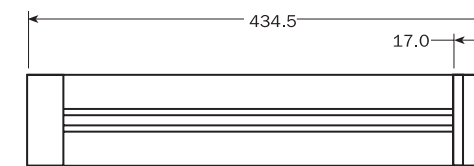
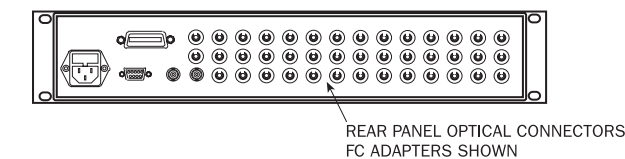
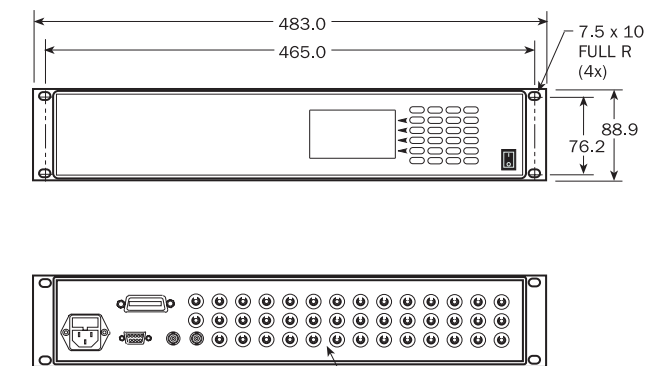

### 2U HALF-RACK CHASSIS

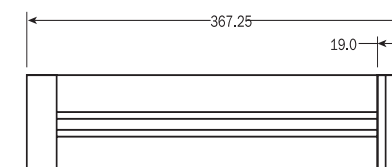
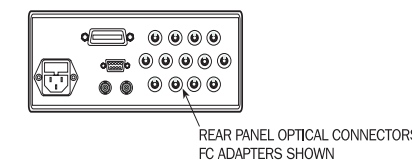
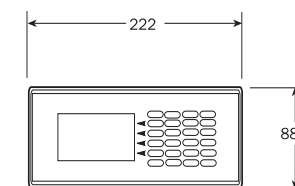

Note: Rackmount hardware available for 2U Half-Rack Chassis. Contact DiCon for Details.

### BENCHTOP CHASSIS

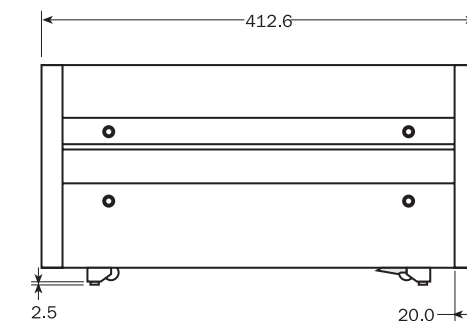
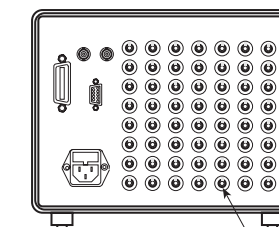
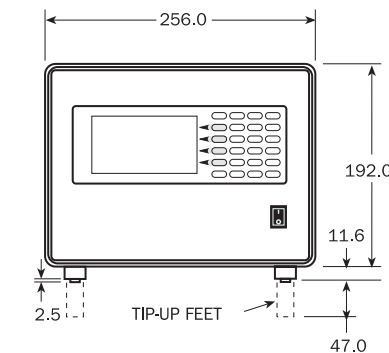

### A NOTE ABOUT CHASSIS SIZE

Not all chassis options are appropriate for all module configurations. Contact DiCon to discuss your requirements.